

Disney Parks Blog

presents:

Disney Paper Parks

Magic Kingdom ~ Holiday Wreath

created by
Stephanie Jazmines
and
Amy Young
of



Walt Disney IMAGINEERING
© Disney

#DisneyMagicMoments #DisneyPaperParks



Disney Paper Parks

#DisneyMagicMoments | #DisneyPaperParks

MAGIC KINGDOM HOLIDAY WREATH

Sheet Numbers: 01 - 15

HISTORY

Every year, the Holiday Services Team at Walt Disney World Resort maintains, installs, and removes more than 40,000 individual pieces of décor across 780 locations at 41 properties. Those include Walt Disney World Theme Parks and Resort hotels, Disney Cruise Line ships and more.

During the holiday season, guests are welcomed to Main Street, U.S.A. with the iconic garlands and wreaths that stretch across the rooftops. Those wreaths are decorated with everything from pinecones and poinsettias to fruit and bows. Some even have a candle in the middle!

This holiday season, we invite you to bring a little Main Street, U.S.A. spirit home with your own Magic Kingdom® Park Holiday Wreath.

INSTRUCTIONS



MATERIALS

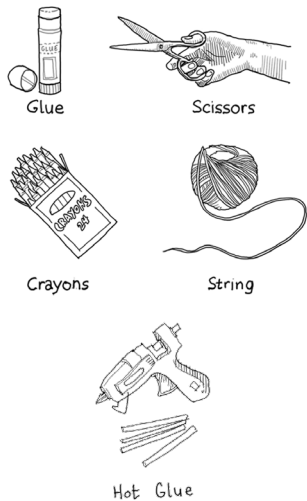

GUIDE

- Lines**
- Valley fold, fold in front
 - - - - - Mountain fold, fold behind
 - Cut
 - X-ray or guide line.

Please Note: When cutting with scissors and working with any of the materials listed above, adult participation and supervision is recommended.

1. Sheet 1: see for Optional Instructions. Please note: you can use any form you'd like to make the wreath. Embroidery hoops, wreath hoops covered in paper, or cardboard can all work!
2. Color the sheets however you'd like! For this activity, we recommend using a hot glue gun for durability, but regular glue will also work.
3. Sheets 2 - 8: Cut out and fold the leaves and branches. It is not necessary to use all the leaves; you can feel free to use whichever you prefer. We recommend using the Pine Branches on Sheet 2 and Sheet 3 as a base layer. Glue them to your chosen hoop, going around the circle in one direction. Add smaller individual leaves or branches on top. You can be artistic with how you arrange and layer!
4. Sheets 9 - 12: Each of these sheets will have their own instructions so you can create any mix of elements you'd like!
5. To finish: Add Box to the front. The Candle can only be placed if you follow the Optional Instructions. If you're making a flatter piece, you can add the Flat Candle instead! Attach a ribbon or string to the back, and your wreath is ready to hang!



OPTIONAL INSTRUCTIONS: WREATH BASE STRUCTURE

1. Use a foam wreath form or cut a hoop out of cardboard. The width of the hoop should be 2 1/2". The diameter can be as big or small as you'd like.

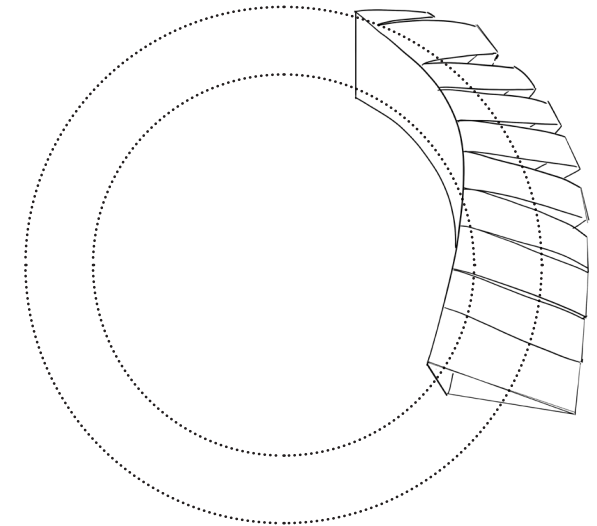
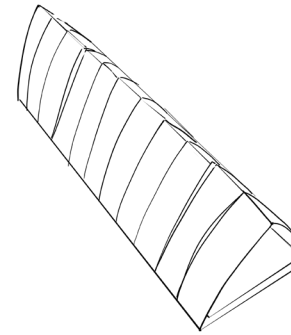
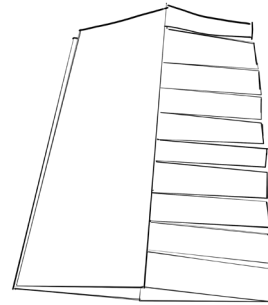
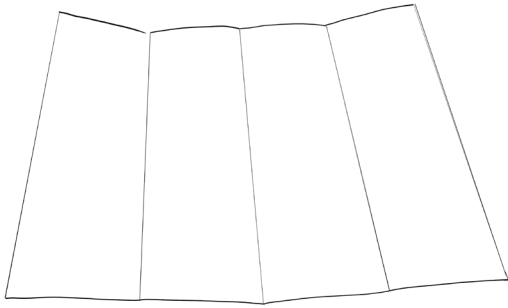

2. Take a plain letter-sized paper and fold it in half along the short edge. Open it up and fold the ends into the center. Now the sheet is divided into 4 parts.
3. Fold the paper in half again and cut 1/2" wide slits from the center crease to the folded line.
4. Overlap the uncut parts. This will form a (triangular) prism shape.
5. Wrap the triangular form around the cardboard hoop, making sure the uncut face is on the inside. Tape or glue into place. Use as many sheets as necessary to cover the entire hoop.

Note: You can also just use a cardboard hoop without additional structure, an embroidery hoop, a foam wreath hoop, or anything else you'd like!



Disney Paper Parks

#DisneyMagicMoments | #DisneyPaperParks

MAGIC KINGDOM HOLIDAY WREATH

Sheet Number: 02

PINE BRANCHES

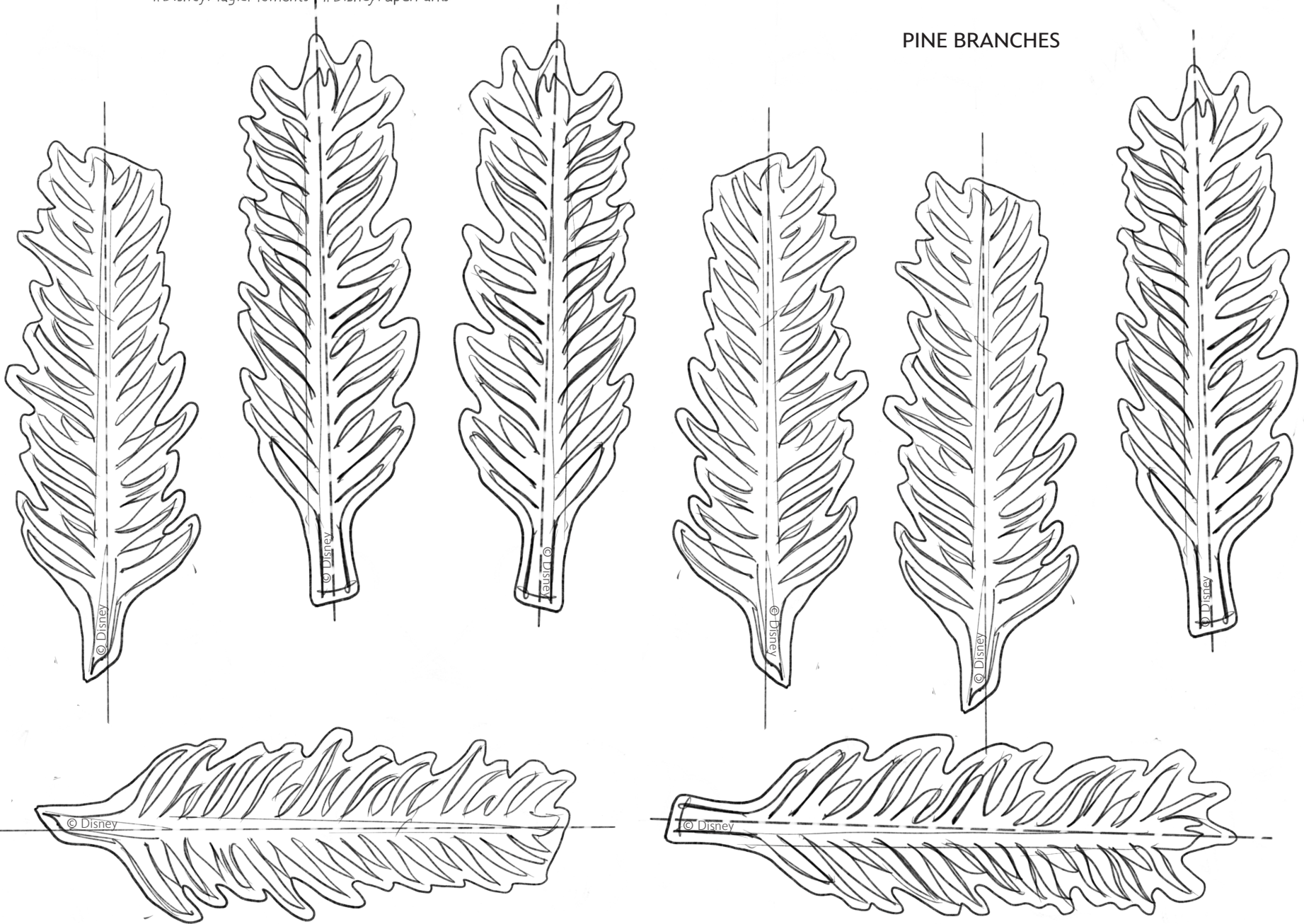



Disney Paper Parks

#DisneyMagicMoments | #DisneyPaperParks

MAGIC KINGDOM HOLIDAY WREATH

Sheet Number: 03

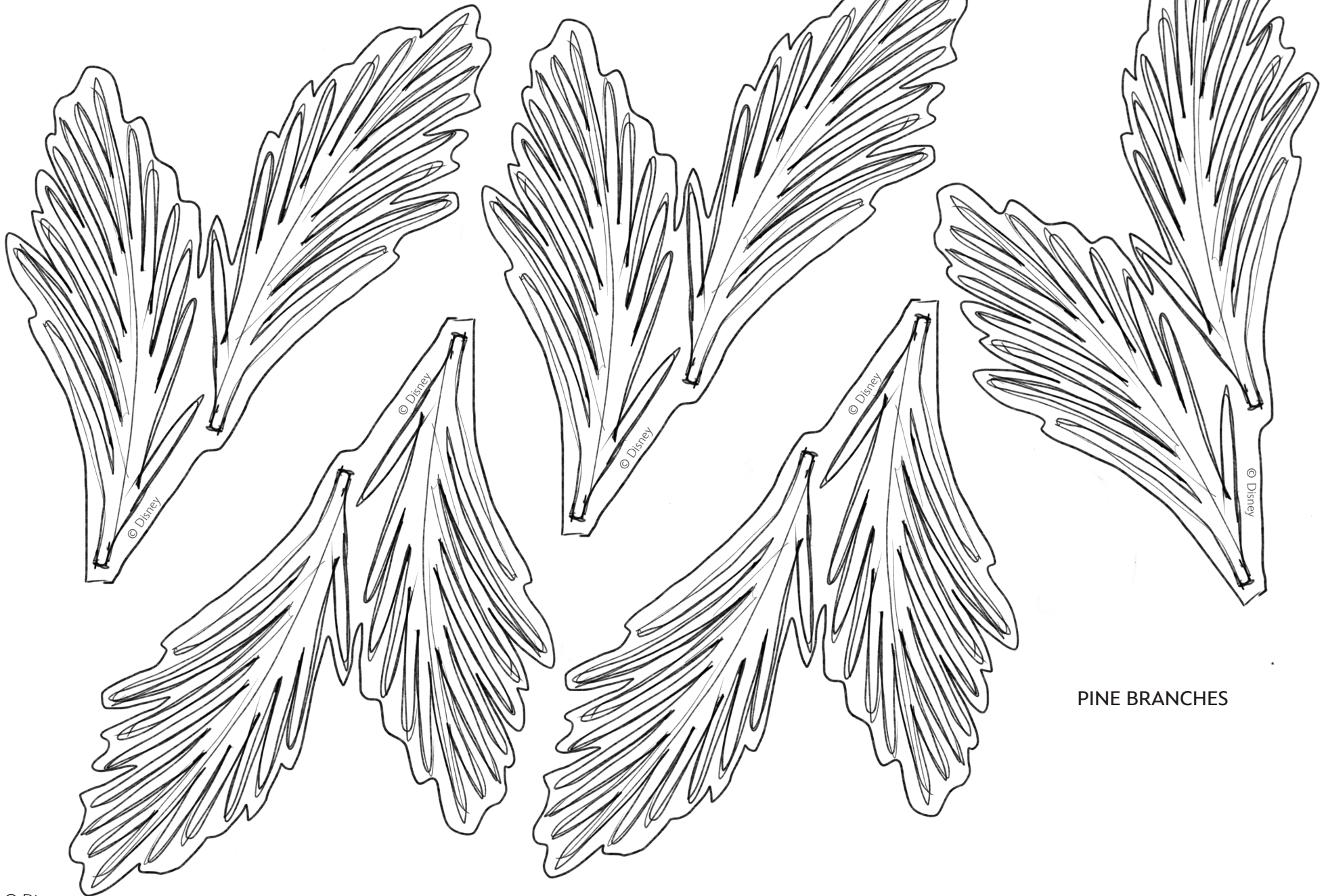

PINE BRANCHES



Disney Paper Parks

#DisneyMagicMoments | #DisneyPaperParks

MAGIC KINGDOM HOLIDAY WREATH

Sheet Number: 04





Disney Paper Parks

#DisneyMagicMoments | #DisneyPaperParks

MAGIC KINGDOM HOLIDAY WREATH

Sheet Number: 05





Disney Paper Parks

#DisneyMagicMoments | #DisneyPaperParks

MAGIC KINGDOM HOLIDAY WREATH

Sheet Number: 06

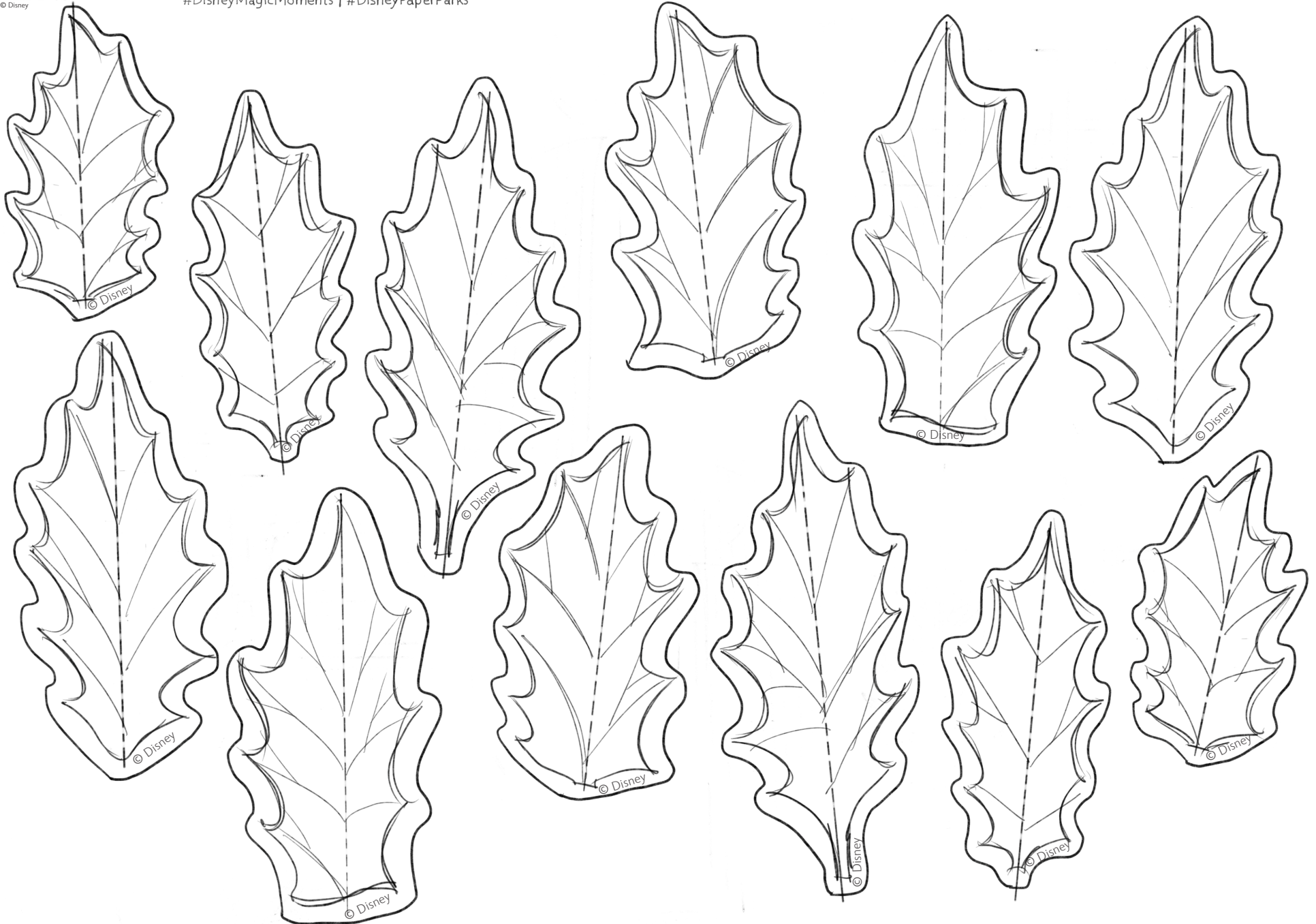



Disney Paper Parks

#DisneyMagicMoments | #DisneyPaperParks

MAGIC KINGDOM HOLIDAY WREATH

Sheet Number: 07

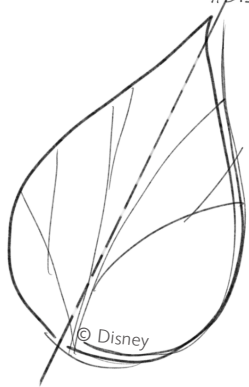

© Disney

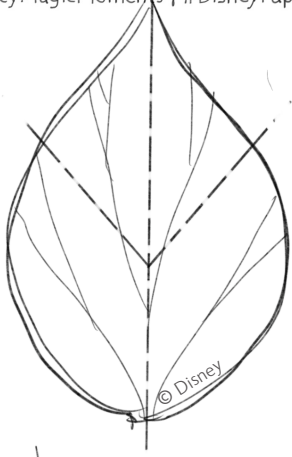

© Disney



© Disney



© Disney



© Disney



© Disney



© Disney



© Disney



© Disney



© Disney



© Disney



© Disney



© Disney

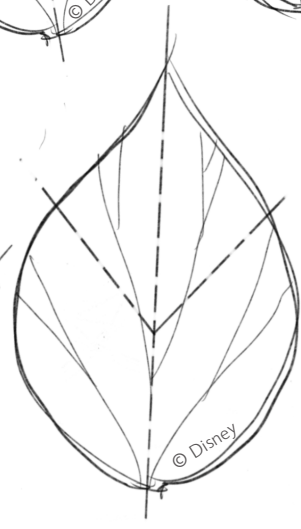

© Disney



© Disney



© Disney



© Disney



© Disney



Disney Paper Parks

#DisneyMagicMoments | #DisneyPaperParks

MAGIC KINGDOM HOLIDAY WREATH

Sheet Number: 08

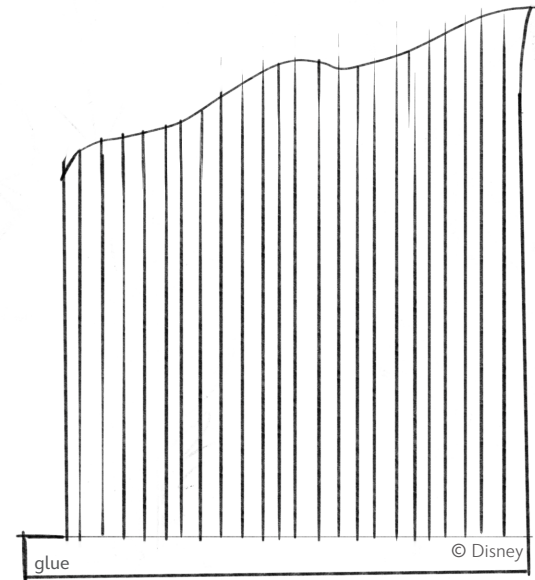
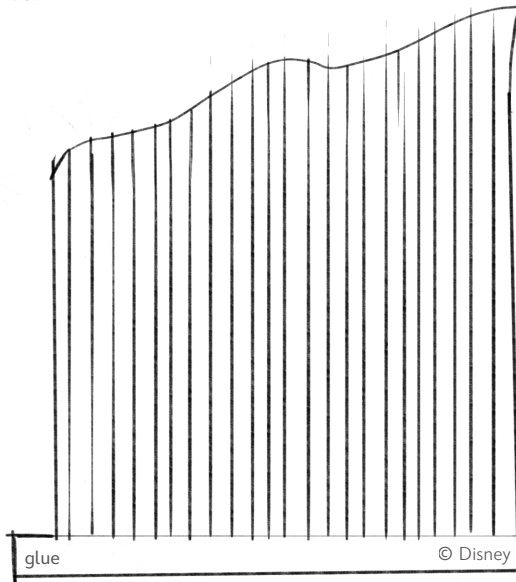
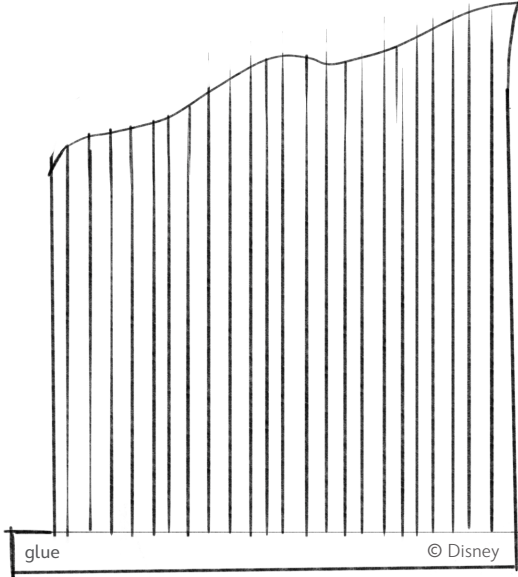

PINE NEEDLES

To make Pine Needles, cut out the overall shape, then cut along each line up to the band to make a fringe. glue the ends together, then fold in half, glue and insert behind other cut leaves.

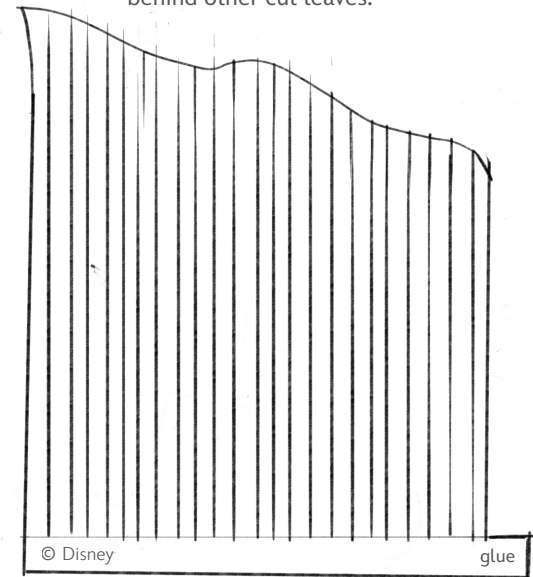
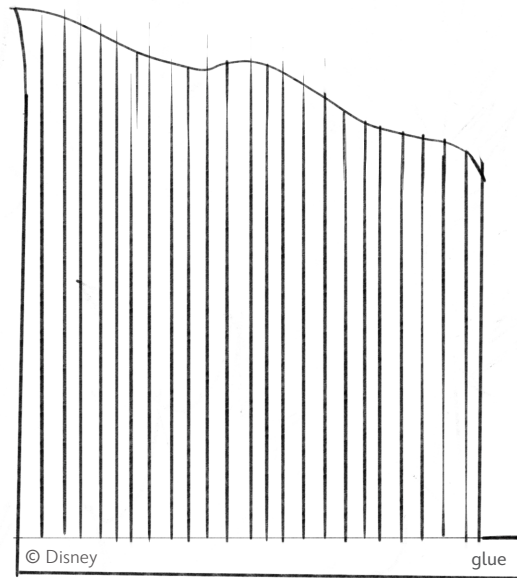
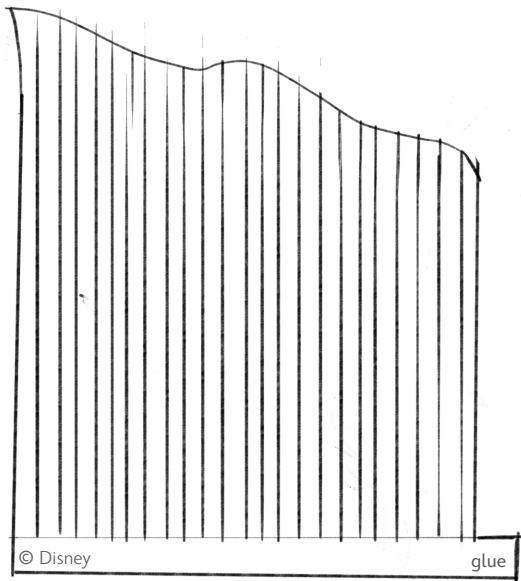



POINSETTIAS

To make Poinsettias, cut out and fold the pieces. Pay attention to which pieces go together. Each poinsettia is made of 2 pieces.



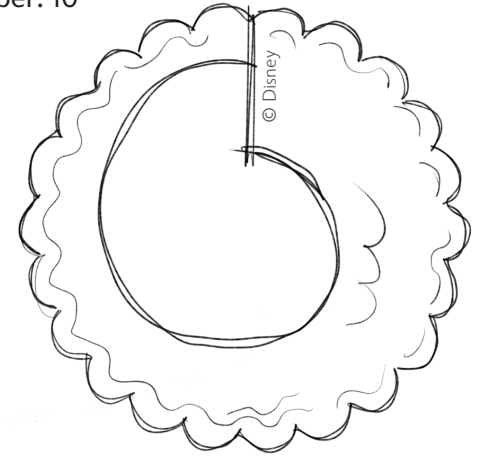
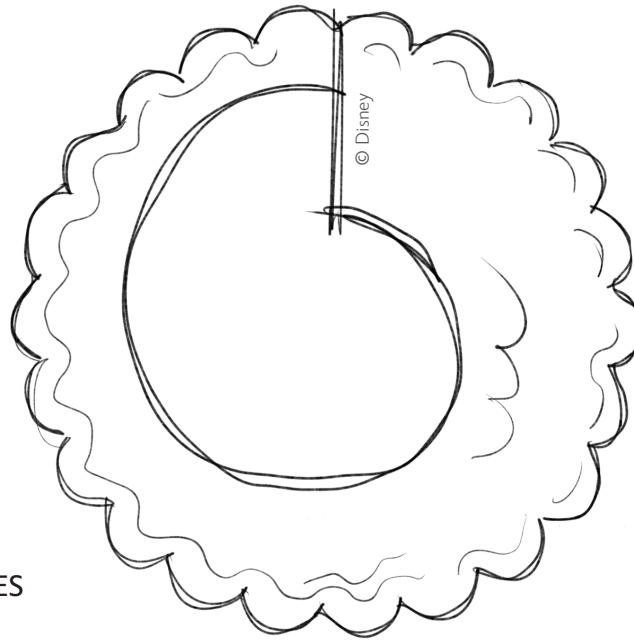
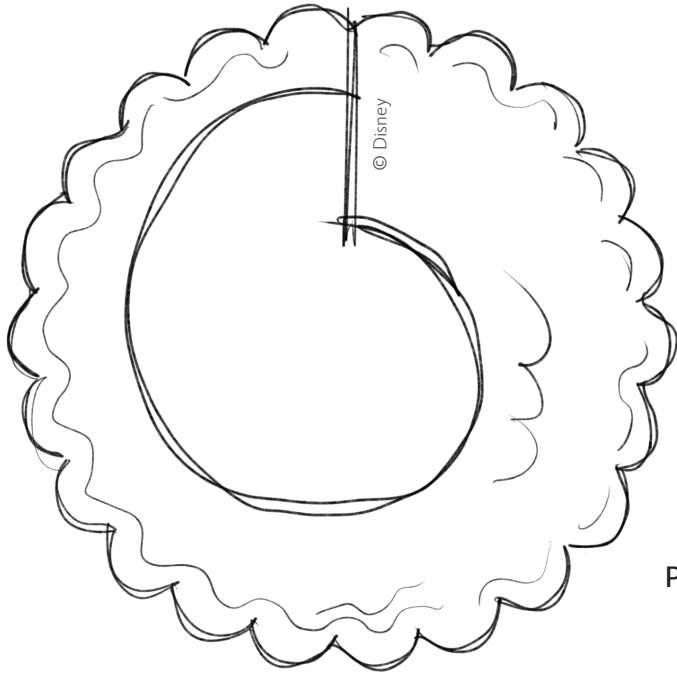

PINECONES

To make Pinecones, cut out each piece on the solid lines. Use a small stick or pencil as a guide and create a spiral as you wrap the paper around. Apply glue to each end to hold in place.

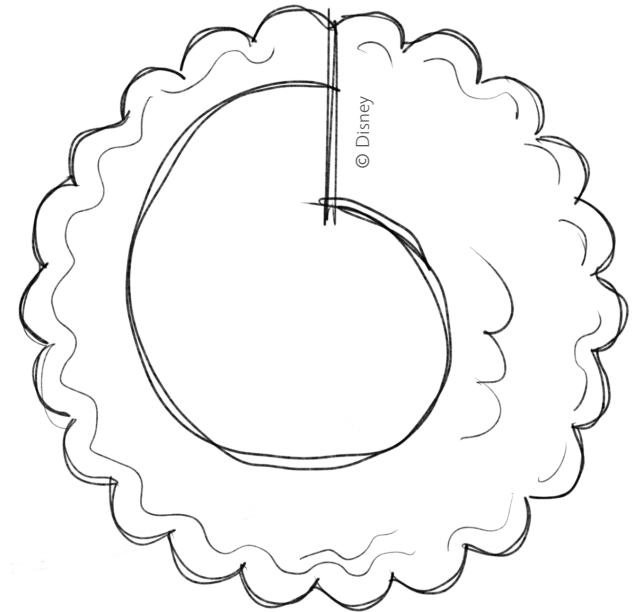
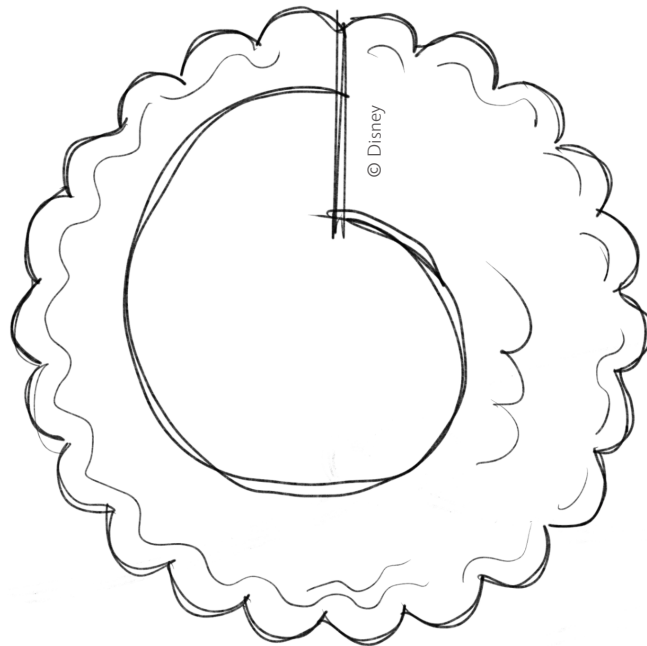
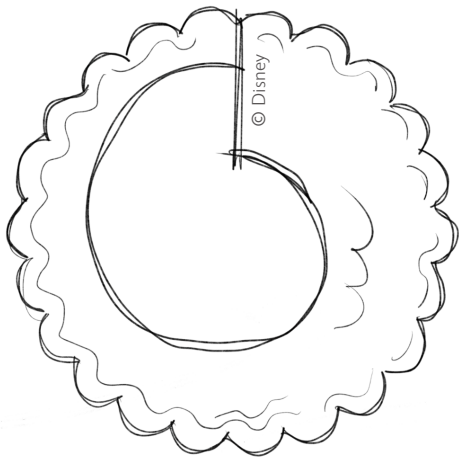



ORNAMENTS AND APPLES

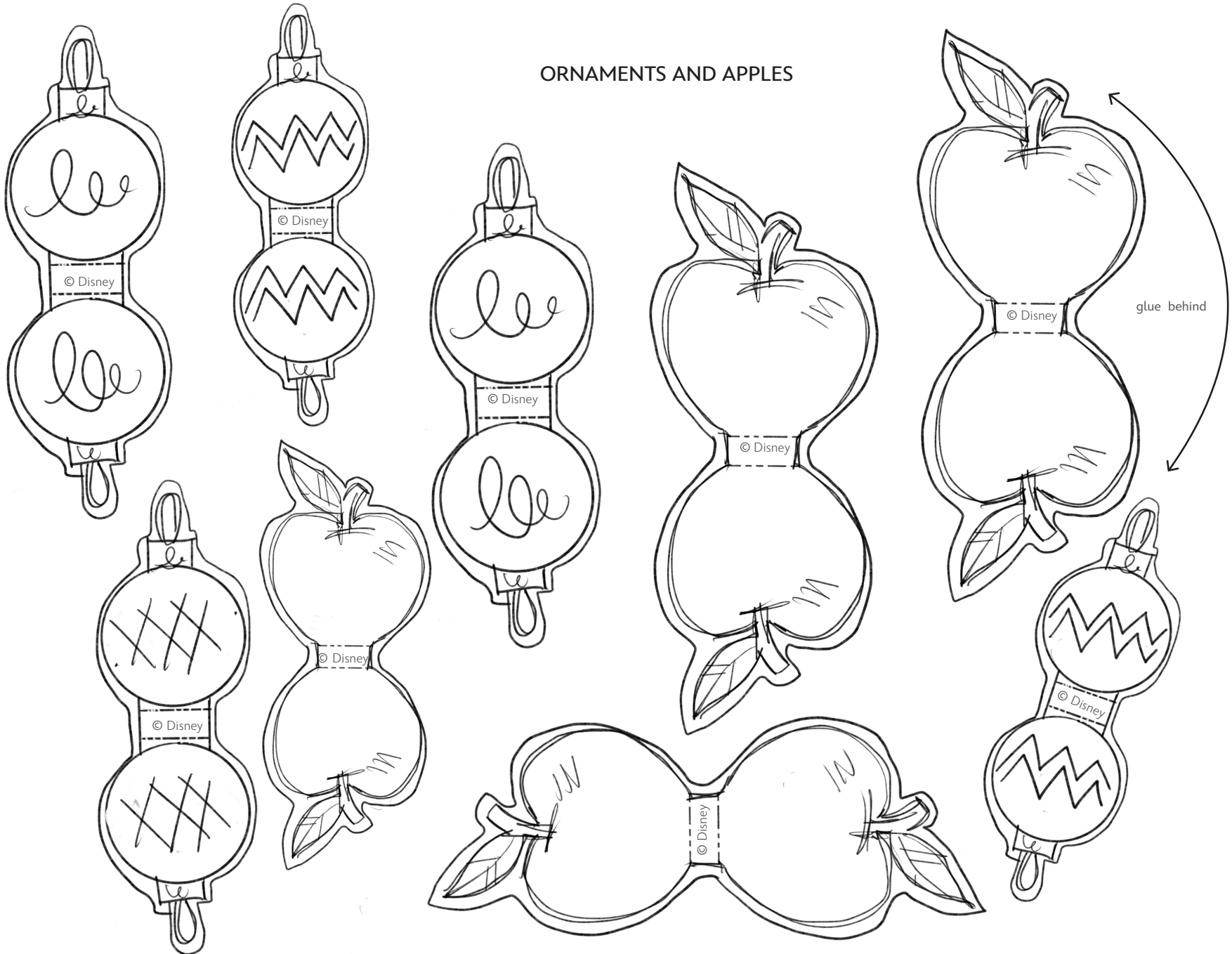



Disney Paper Parks

#DisneyMagicMoments | #DisneyPaperParks

MAGIC KINGDOM HOLIDAY WREATH

Sheet Number: 12

DIMENSIONAL CANDLE

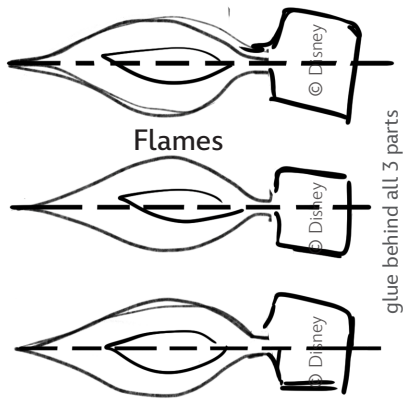

To make Dimensional Candle:

1. Cut out Main Body. Roll into cylinder and glue ends.
2. Cut out Flames and fold in half. Glue the backs of the halves together to form a Y shape.
3. Cut out Candle Top. Be sure to cut the Y in the center. Slip the Flame through the slits. Glue if needed. Glue the tabs to the outside top of the Main Body.

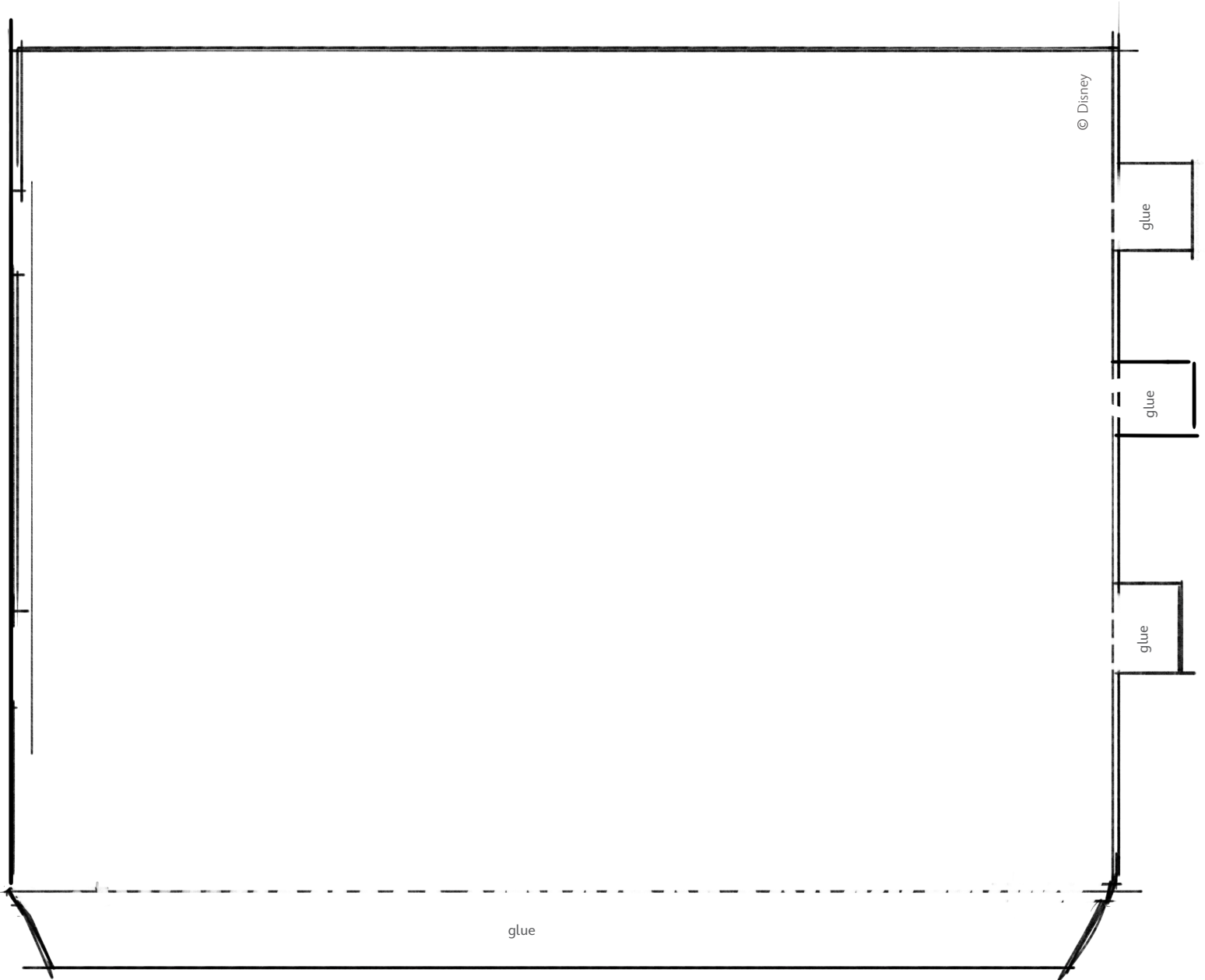

Main Body



Disney Paper Parks

#DisneyMagicMoments | #DisneyPaperParks

MAGIC KINGDOM HOLIDAY WREATH

Sheet Number: 13

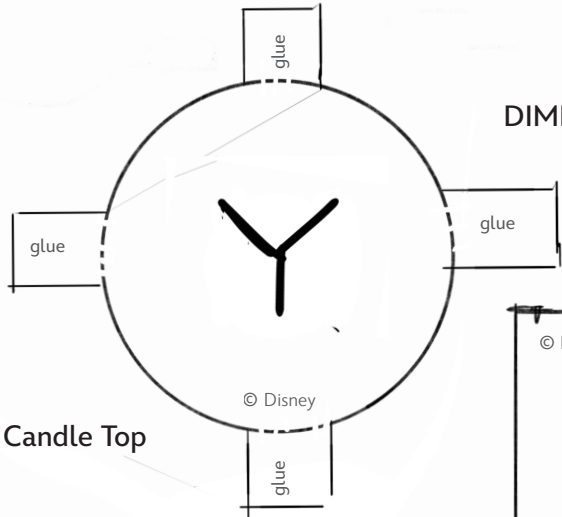

Candle Top

DIMENSIONAL CANDLE CONT'D

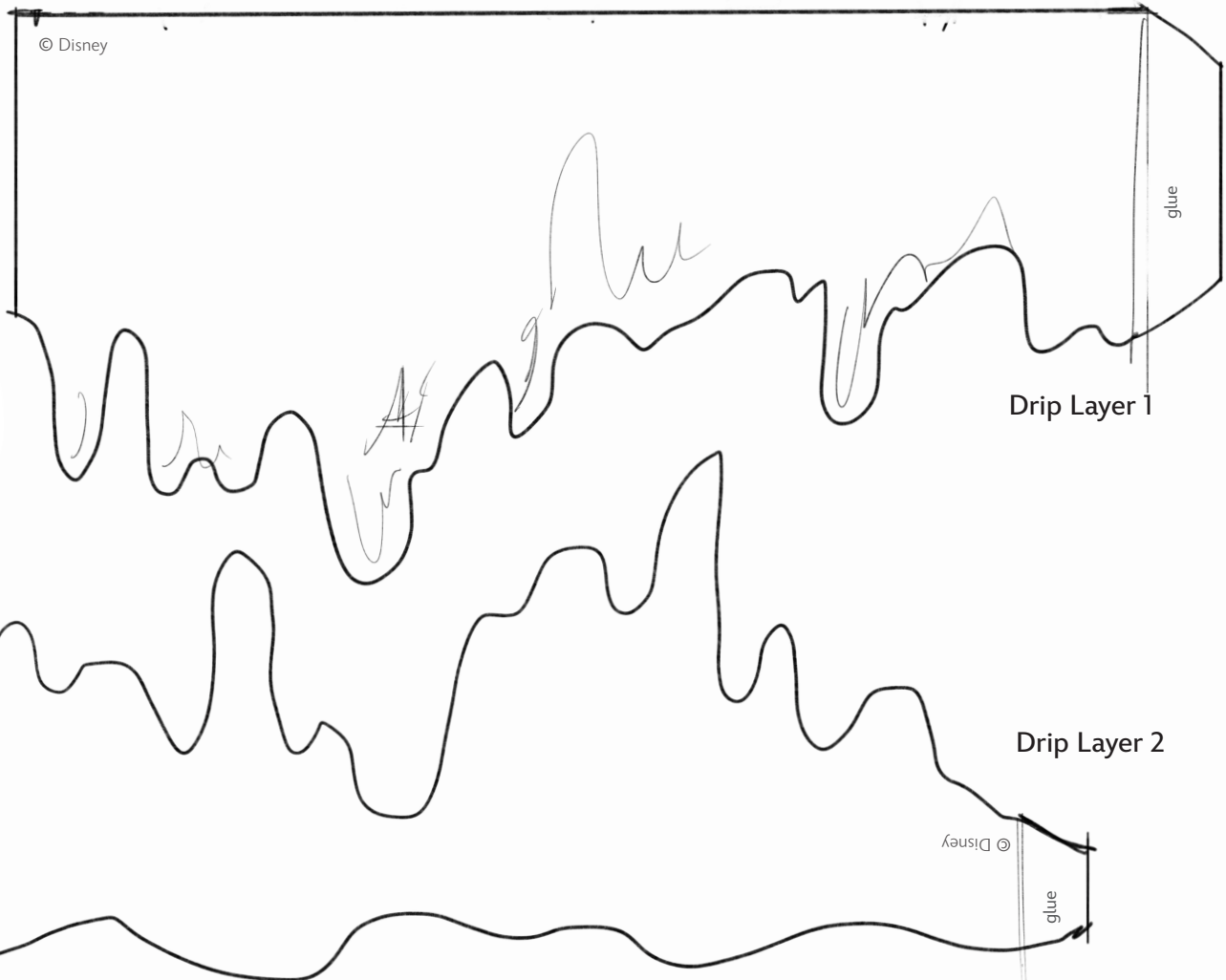

Drip Layer 1

Drip Layer 2

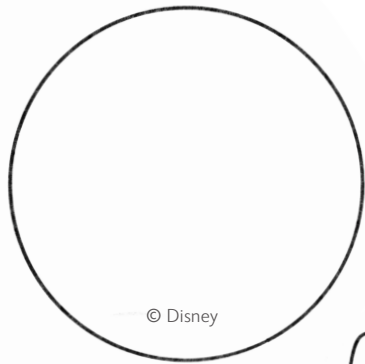

Candle Bottom

4. Cut out Candle Bottom and glue to the tabs on the bottom of the Main Body.
5. Cut out Drip Layer 1. Wrap around the top of the Main Body and glue behind to stay in place. Glue the tab and together.
6. Add Drop Layer 2 on top of Drip Layer 1. Have the top extend over the top of the Main Body to add depth!

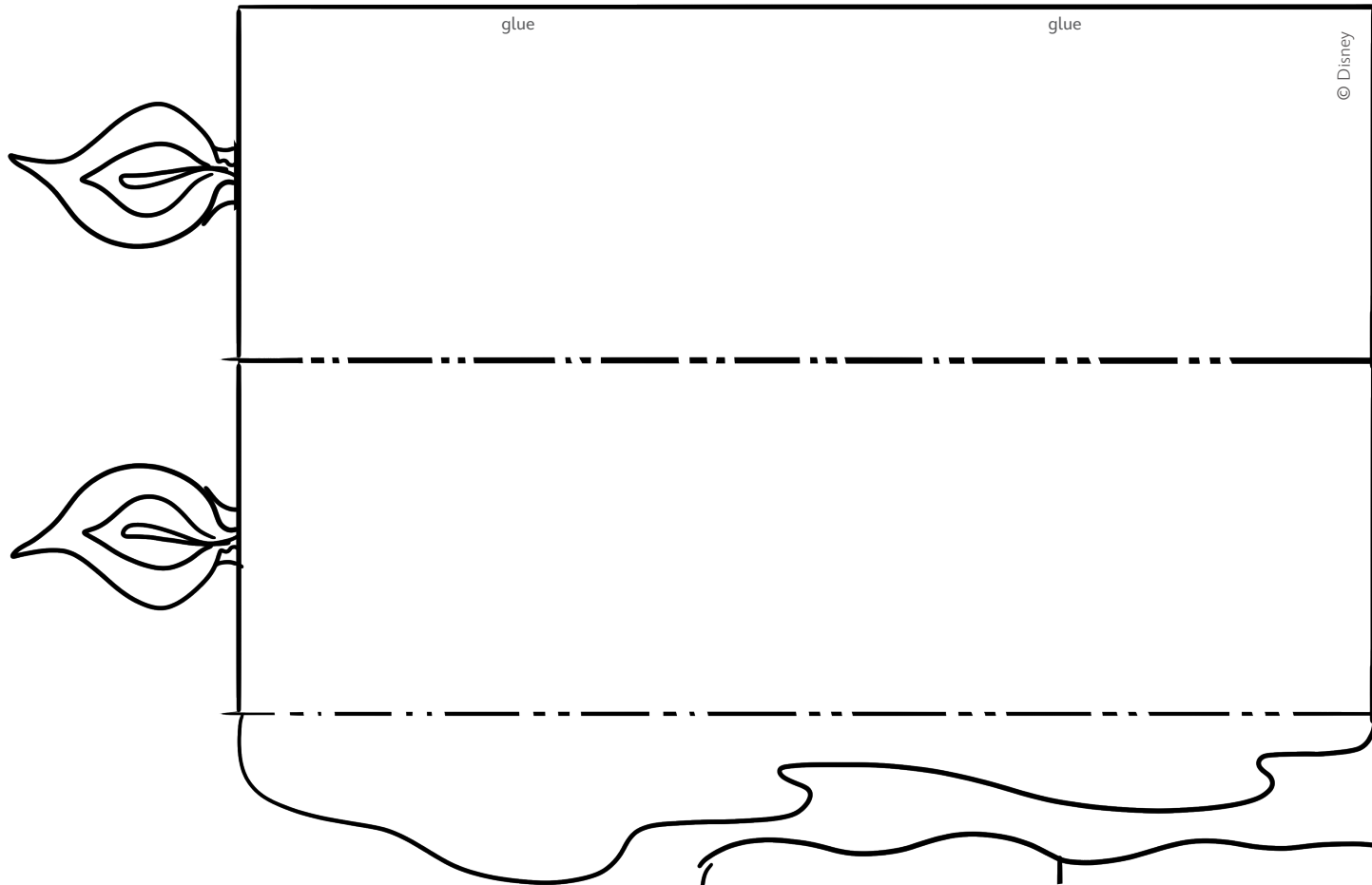

2D OPTION: FLAT CANDLE

1. Cut out the large section, fold where indicated. Fold the end over to cover the edge and glue in place.
2. Apply Drip Layer on top, fold over and glue in place.
3. Glue to bottom of the wreath and cover with the Holiday Bow or additional leaves.

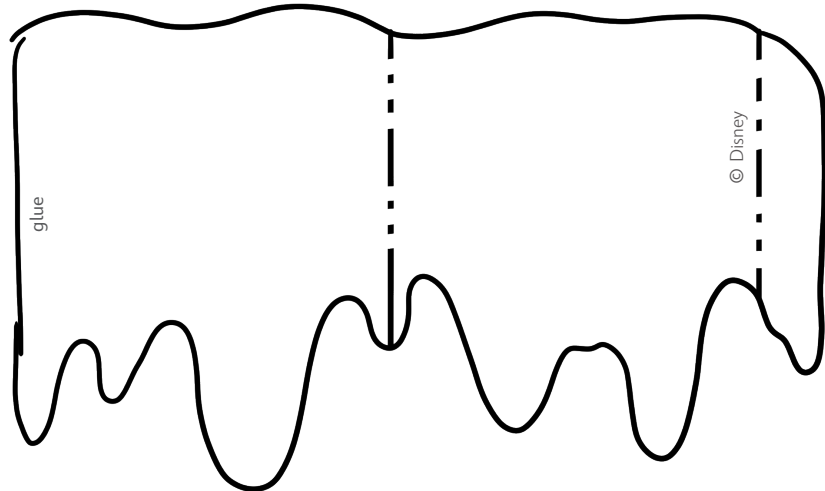

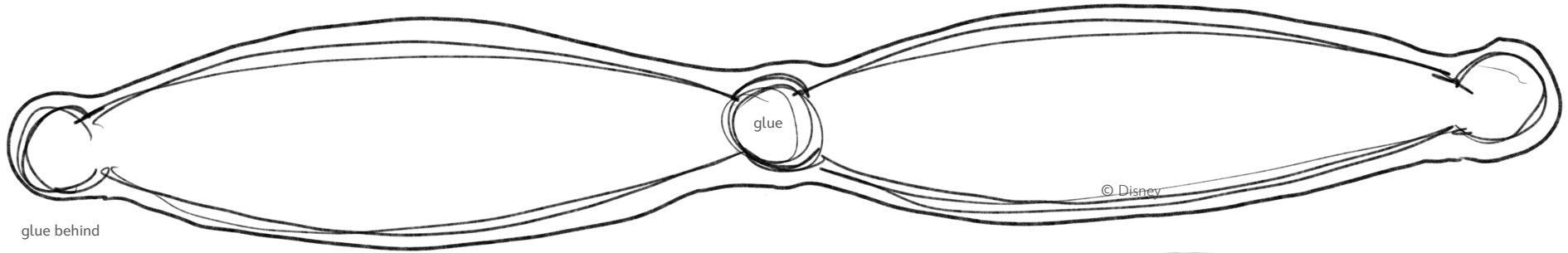

glue behind

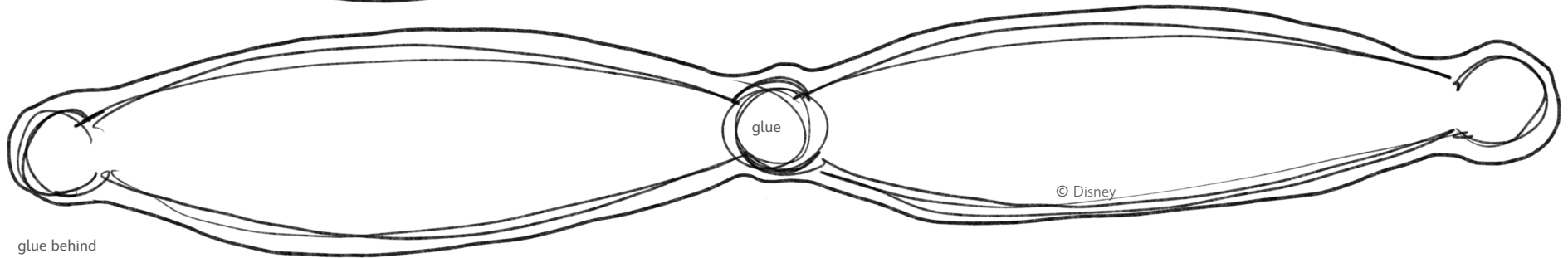

glue behind

HOLIDAY BOW

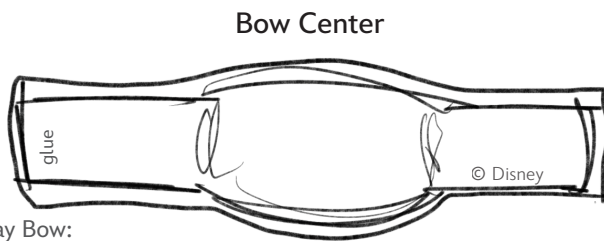

Bow Center

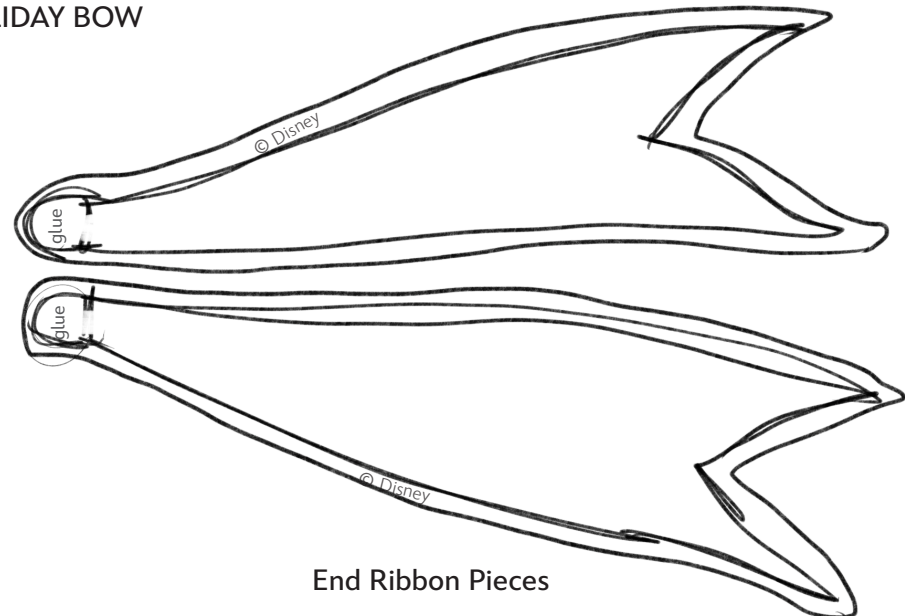

End Ribbon Pieces

To make Holiday Bow:

1. Cut out the two longest pieces. Bend the paper so the circular parts overlap each other on each piece. Apply glue. Then glue the two parts on top of one another at the center.
2. Take the End Ribbon pieces and glue to the back of the center.
3. Take the Bow Center and wrap it around the middle and glue the back to keep everything in place!